

PROJECT
TYPE
SPECIFIER
QUANTITY
DATE

## PIXEL SPHERE SUSPENSION

### D1010059-

base number      Color      Finish  
 Temperature      Options

- To build a product code in our configurator select the specify button on the base model # product page
- To build a manual product code on this datasheet choose from the options listed below in blue font and add the suffix to the base model #

#### GENERAL

Series: Pixel Sphere  
 Partner: Quasar  
 Division: Design  
 Installation: Suspension  
 Product Type: Chandelier  
 Mounting Location: Ceiling

#### PHYSICAL

Shape: Sphere  
 Diameter (mm): 2030  
 Diameter (in): 79 <sup>15</sup>/<sub>16</sub>"  
 Height (mm): 1700  
 Height (in): 66 <sup>15</sup>/<sub>16</sub>"  
 Max. Overall Height (mm): 3700  
 Max. Overall Height (in): 145 <sup>11</sup>/<sub>16</sub>"  
 Fixture Finish: [NIC / BRA / BBR](#)  
 Fixture Material: Metal  
 Cable Details: 2000mm/78 3/4" Transparent Cable

#### ELECTRICAL

Lamp Type: LED  
 Input Wattage (W): 876  
 Total Output Wattage (W): 745  
 Max. Wattage Per Lamp (W): 0.6  
 Dimming: Phase Dimming (120Vac Only)  
 Driver Included: Yes  
 Driver Location: Integrated  
 Driver Type: Constant Voltage - Universal  
 Driver Class: Class 1  
 Input Voltage (V): 120 - 277  
 Output Voltage (V): 12

#### LED

Number of LEDs: 1476  
 Color Temperature (°K): [2400 / 2800](#)  
 Max. Delivered Lumen (lm): 44280  
 CRI: >90 CRI  
 Lamp Life (hrs): 50000

#### OPTICAL

#### RATINGS AND CERTIFICATIONS

Certified By: Certified for North American Standards  
 IP rating: IP20

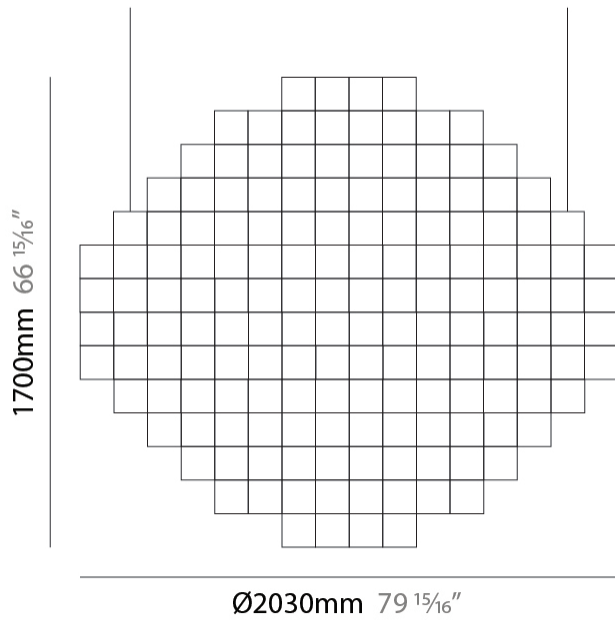
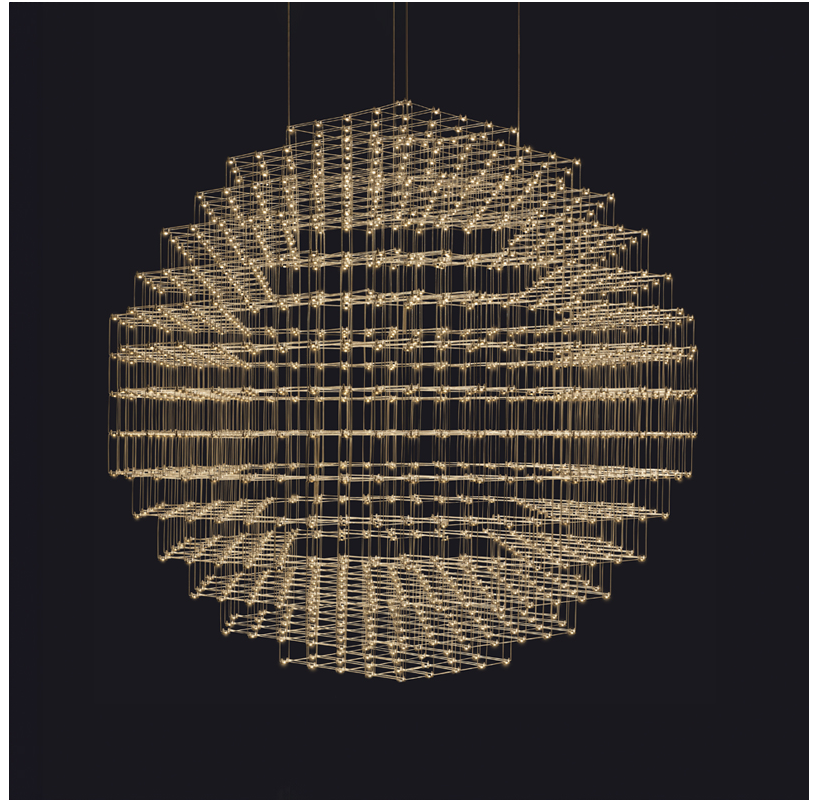

## PIXEL SPHERE SUSPENSION

D1010059-

PROJECT

TYPE

SPECIFIER

QUANTITY

DATE

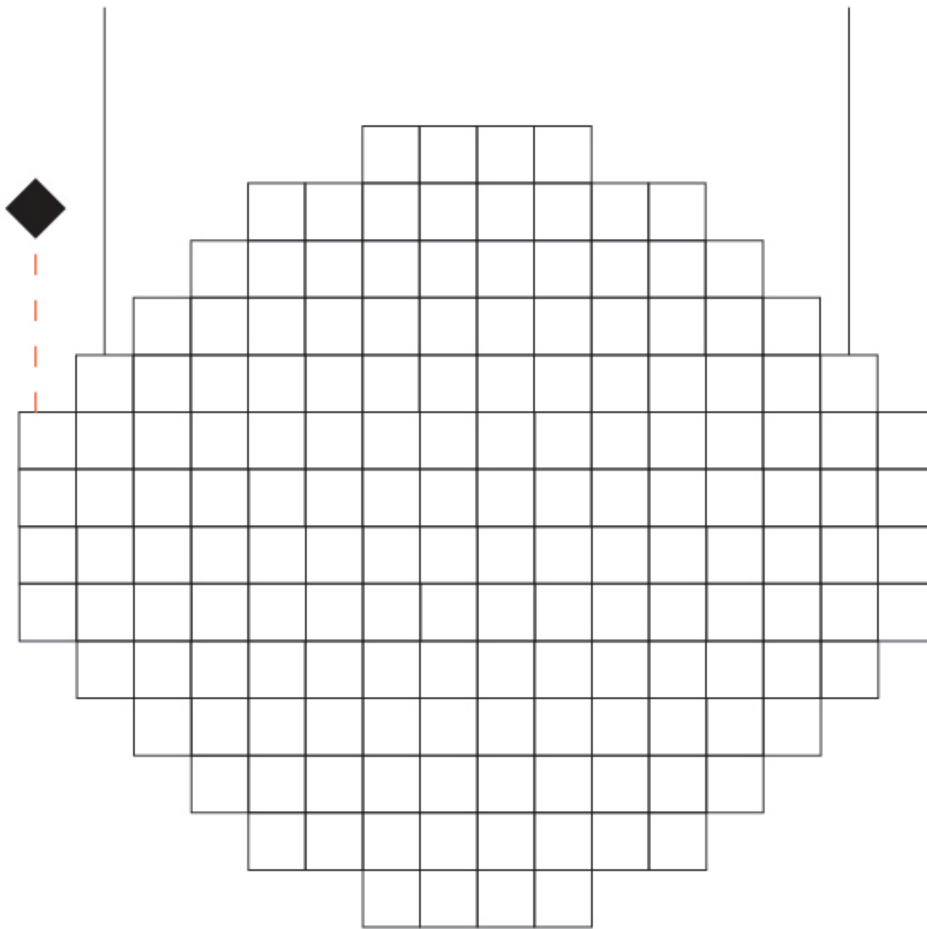

D

## PIXEL SPHERE SUSPENSION

### D1010076-

base number      Color      Finish  
 Temperature      Options

- To build a product code in our configurator select the specify button on the base model # product page
- To build a manual product code on this datasheet choose from the options listed below in blue font and add the suffix to the base model #

#### GENERAL

Series: Pixel Sphere  
 Partner: Quasar  
 Division: Design  
 Installation: Suspension  
 Product Type: Chandelier  
 Mounting Location: Ceiling

#### PHYSICAL

Shape: Sphere  
 Diameter (mm): 900  
 Diameter (in): 35 <sup>7</sup>/<sub>16</sub>  
 Width (mm): 100  
 Width (in): 4 <sup>15</sup>/<sub>16</sub>  
 Height (mm): 100  
 Height (in): 4 <sup>15</sup>/<sub>16</sub>  
 Max. Overall Height (mm): 2100  
 Max. Overall Height (in): 82 <sup>11</sup>/<sub>16</sub>  
 Fixture Finish: [NIC](#) / [BRA](#) / [BBR](#)  
 Fixture Material: Metal  
 Cable Details: 2,000mm/78 3/4" Transparent Cable

#### ELECTRICAL

Lamp Type: LED  
 Input Wattage (W): 288  
 Total Output Wattage (W): 245  
 Max. Wattage Per Lamp (W): 0.6  
 Dimming: 0-10V Dimming / Phase Dimming (120Vac Only)  
 Driver Included: Yes  
 Driver Location: Integrated  
 Driver Type: Constant Voltage - Universal  
 Driver Class: Class 1  
 Input Voltage (V): 120 - 277  
 Output Voltage (V): 12

#### LED

Number of LEDs: 480  
 Color Temperature (°K): [2400](#) / [2800](#)  
 Max. Delivered Lumen (lm): 14400  
 CRI: >90 CRI  
 Lamp Life (hrs): 50000

#### OPTICAL

#### RATINGS AND CERTIFICATIONS

Certified By: Certified for North American Standards  
 IP rating: IP20

PROJECT \_\_\_\_\_  
 TYPE \_\_\_\_\_  
 SPECIFIER \_\_\_\_\_  
 QUANTITY \_\_\_\_\_  
 DATE \_\_\_\_\_

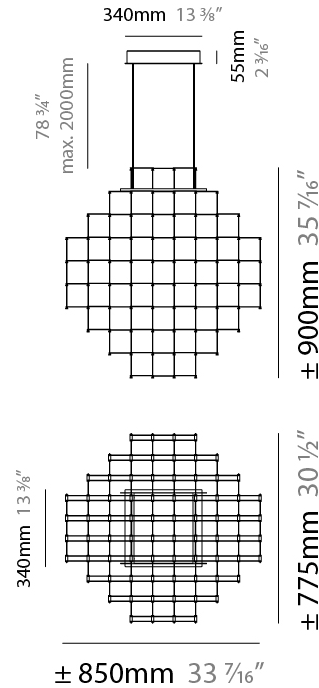
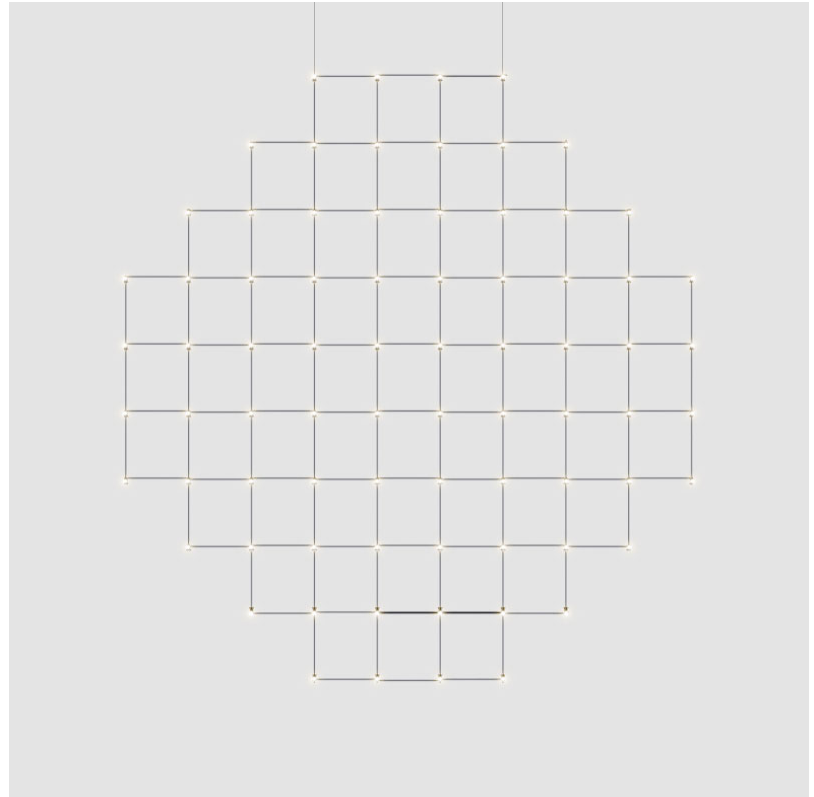

## PIXEL SPHERE SUSPENSION

D1010076-

PROJECT

TYPE

SPECIFIER

QUANTITY

DATE

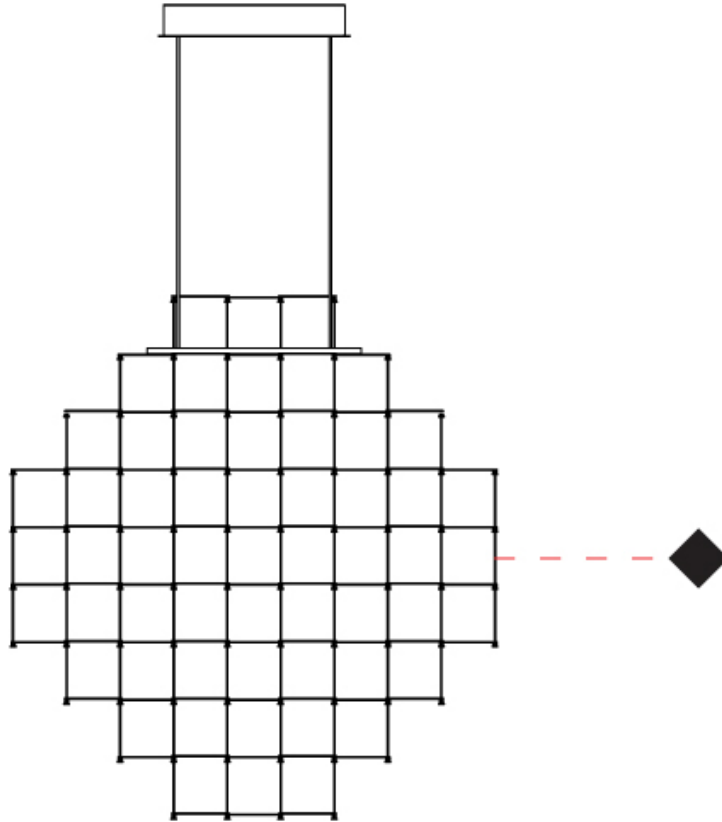

D

## PIXEL SPHERE SUSPENSION

**D1010077-** -

base number      Color      Finish  
 Temperature      Options

PROJECT \_\_\_\_\_  
 TYPE \_\_\_\_\_  
 SPECIFIER \_\_\_\_\_  
 QUANTITY \_\_\_\_\_  
 DATE \_\_\_\_\_

- To build a product code in our configurator select the specify button on the base model # product page
- To build a manual product code on this datasheet choose from the options listed below in blue font and add the suffix to the base model #

### GENERAL

Series: Pixel Sphere  
 Partner: Quasar  
 Division: Design  
 Installation: Suspension  
 Product Type: Chandelier  
 Mounting Location: Ceiling

### PHYSICAL

Shape: Sphere  
 Diameter (mm): 900  
 Diameter (in): 35 <sup>7</sup>/<sub>16</sub>  
 Width (mm): 125  
 Width (in): 4 <sup>15</sup>/<sub>16</sub>  
 Height (mm): 125  
 Height (in): 4 <sup>15</sup>/<sub>16</sub>  
 Max. Overall Height (mm): 2125  
 Max. Overall Height (in): 83 <sup>11</sup>/<sub>16</sub>  
 Fixture Finish: [NIC](#) / [BRA](#) / [BBR](#)  
 Fixture Material: Metal  
 Cable Details: 2,000mm/78 3/4" Transparent Cable

### ELECTRICAL

Lamp Type: LED  
 Input Wattage (W): 168  
 Total Output Wattage (W): 143  
 Max. Wattage Per Lamp (W): 0.6  
 Dimming: 0-10V Dimming / Phase Dimming (120Vac Only)  
 Driver Included: Yes  
 Driver Location: Integrated  
 Driver Type: Constant Voltage - Universal  
 Driver Class: Class 1  
 Input Voltage (V): 120 - 277  
 Output Voltage (V): 12

### LED

Number of LEDs: 280  
 Color Temperature (°K): [2400](#) / [2800](#)  
 Max. Delivered Lumen (lm): 4800  
 CRI: >90 CRI  
 Lamp Life (hrs): 50000

### OPTICAL

### RATINGS AND CERTIFICATIONS

Certified By: Certified for North American Standards  
 IP rating: IP20

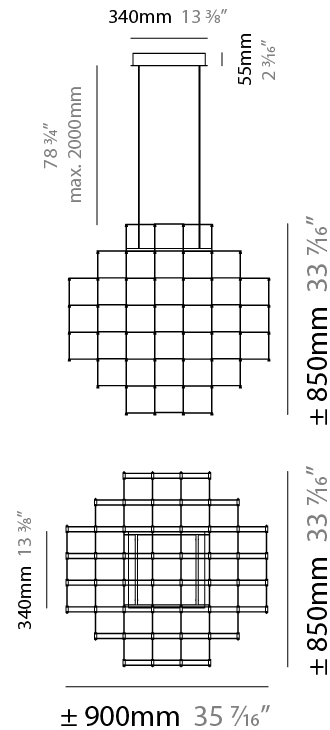
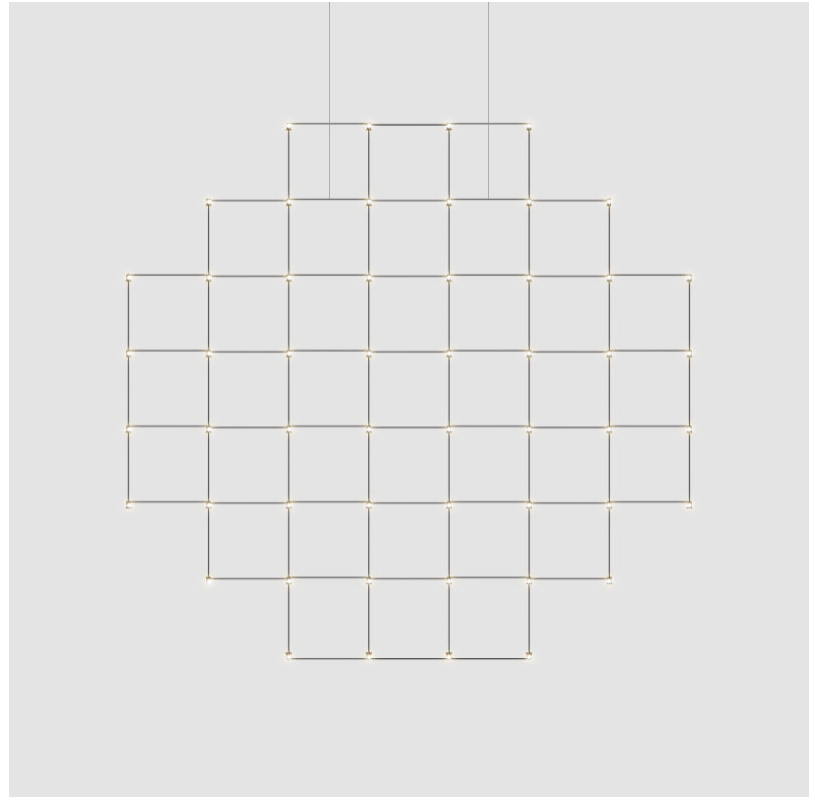

## PIXEL SPHERE SUSPENSION

D1010077-

PROJECT

TYPE

SPECIFIER

QUANTITY

DATE

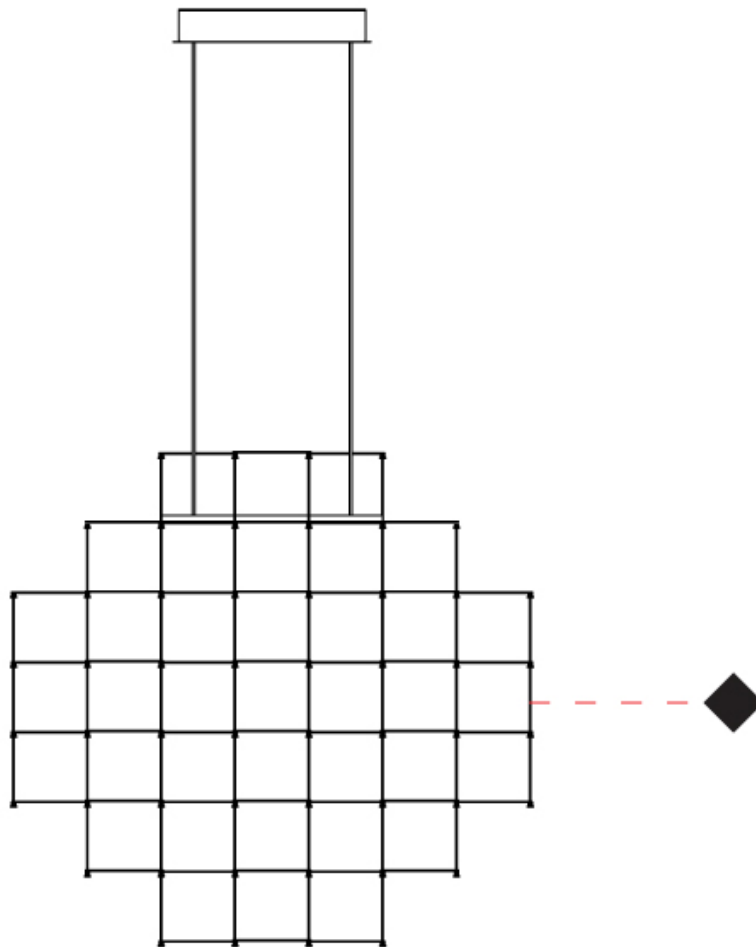

D

PROJECT	
TYPE	
SPECIFIER	
QUANTITY	
DATE	

## PIXEL SPHERE SUSPENSION

### D1010078-

base number      Color      Finish  
 Temperature      Options

- To build a product code in our configurator select the specify button on the base model # product page
- To build a manual product code on this datasheet choose from the options listed below in blue font and add the suffix to the base model #

#### GENERAL

Series: Pixel Sphere  
 Partner: Quasar  
 Division: Design  
 Installation: Suspension  
 Product Type: Chandelier  
 Mounting Location: Ceiling

#### PHYSICAL

Shape: Sphere  
 Diameter (mm): 1100  
 Diameter (in): 43 <sup>15</sup>/<sub>16</sub>  
 Width (mm): 100  
 Width (in): 3 <sup>15</sup>/<sub>16</sub>  
 Height (mm): 100  
 Height (in): 3 <sup>15</sup>/<sub>16</sub>  
 Max. Overall Height (mm): 2100  
 Max. Overall Height (in): 82 <sup>11</sup>/<sub>16</sub>  
 Fixture Finish: [NIC](#) / [BRA](#) / [BBR](#)  
 Fixture Material: Metal  
 Cable Details: 2,000mm/78 3/4" Transparent Cable

#### ELECTRICAL

Lamp Type: LED  
 Input Wattage (W): 408  
 Total Output Wattage (W): 347  
 Max. Wattage Per Lamp (W): 0.6  
 Dimming: 0-10V Dimming / Phase Dimming (120Vac Only)  
 Driver Included: Yes  
 Driver Location: Integrated  
 Driver Type: Constant Voltage - Universal  
 Driver Class: Class 1  
 Input Voltage (V): 120 - 277  
 Output Voltage (V): 12

#### LED

Number of LEDs: 680  
 Color Temperature (°K): [2400](#) / [2800](#)  
 Max. Delivered Lumen (lm): 20400  
 CRI: >90 CRI  
 Lamp Life (hrs): 50000

#### OPTICAL

#### RATINGS AND CERTIFICATIONS

Certified By: Certified for North American Standards  
 IP rating: IP20

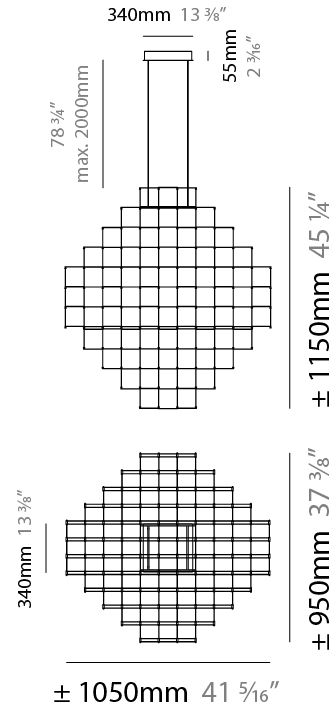
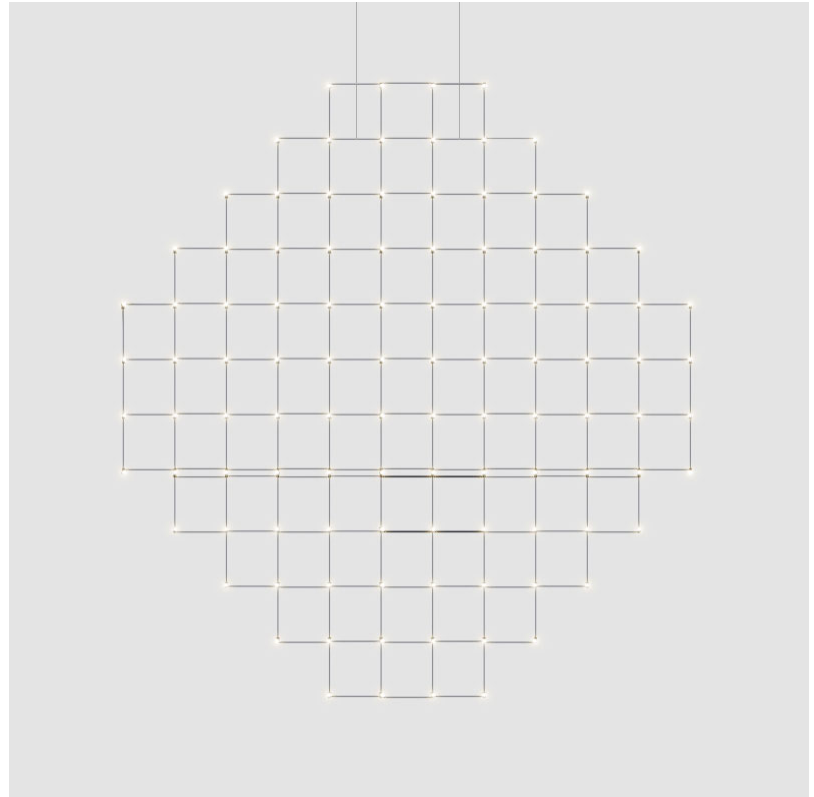

## PIXEL SPHERE SUSPENSION

D1010078-

PROJECT

TYPE

SPECIFIER

QUANTITY

DATE

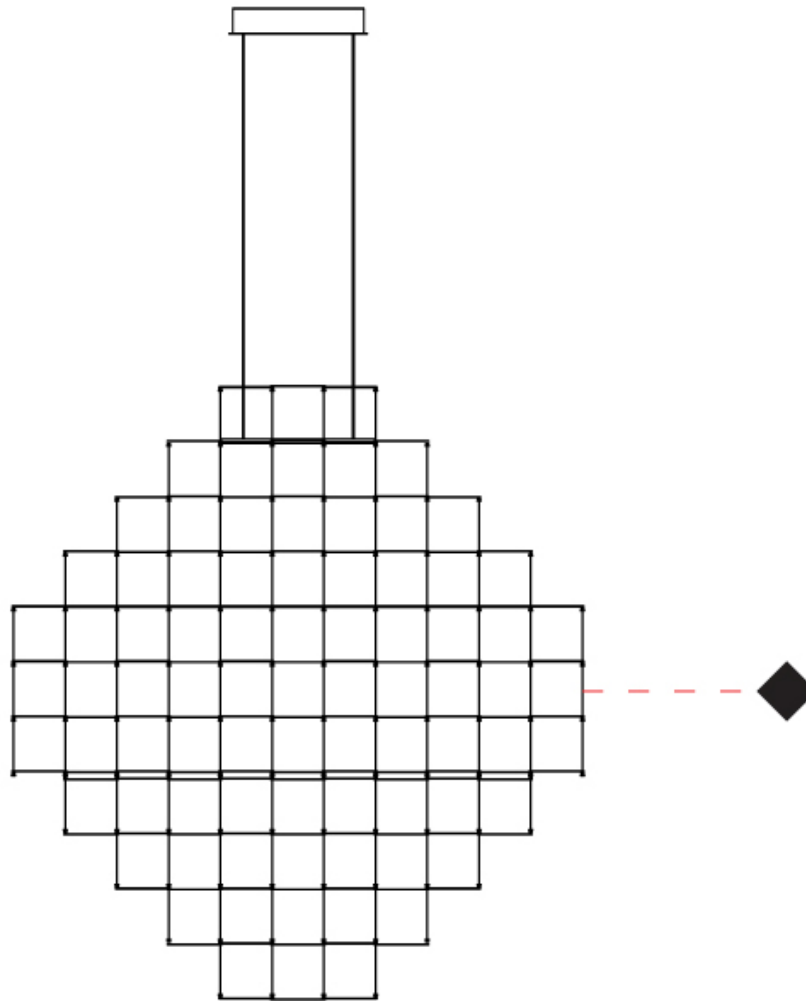

D

## PIXEL SPHERE SUSPENSION

### D1010079- -

base number      Color      Finish  
 Temperature      Options

- To build a product code in our configurator select the specify button on the base model # product page
- To build a manual product code on this datasheet choose from the options listed below in blue font and add the suffix to the base model #

#### GENERAL

Series: Pixel Sphere  
 Partner: Quasar  
 Division: Design  
 Installation: Suspension  
 Product Type: Chandelier  
 Mounting Location: Ceiling

#### PHYSICAL

Shape: Sphere  
 Diameter (mm): 1100  
 Diameter (in): 43 <sup>15</sup>/<sub>16</sub>  
 Width (mm): 125  
 Width (in): 4 <sup>15</sup>/<sub>16</sub>  
 Height (mm): 125  
 Height (in): 4 <sup>15</sup>/<sub>16</sub>  
 Max. Overall Height (mm): 2125  
 Max. Overall Height (in): 83 <sup>11</sup>/<sub>16</sub>  
 Fixture Finish: [NIC](#) / [BRA](#) / [BBR](#)  
 Fixture Material: Metal  
 Cable Details: 2,000mm/78 3/4" Transparent Cable

#### ELECTRICAL

Lamp Type: LED  
 Input Wattage (W): 288  
 Total Output Wattage (W): 245  
 Max. Wattage Per Lamp (W): 0.6  
 Dimming: 0-10V Dimming / Phase Dimming (120Vac Only)  
 Driver Included: Yes  
 Driver Location: Integrated  
 Driver Type: Constant Voltage - Universal  
 Driver Class: Class 1  
 Input Voltage (V): 120 - 277  
 Output Voltage (V): 12

#### LED

Number of LEDs: 480  
 Color Temperature (°K): [2400](#) / [2800](#)  
 Max. Delivered Lumen (lm): 14400  
 CRI: >90 CRI  
 Lamp Life (hrs): 50000

#### OPTICAL

#### RATINGS AND CERTIFICATIONS

Certified By: Certified for North American Standards  
 IP rating: IP20

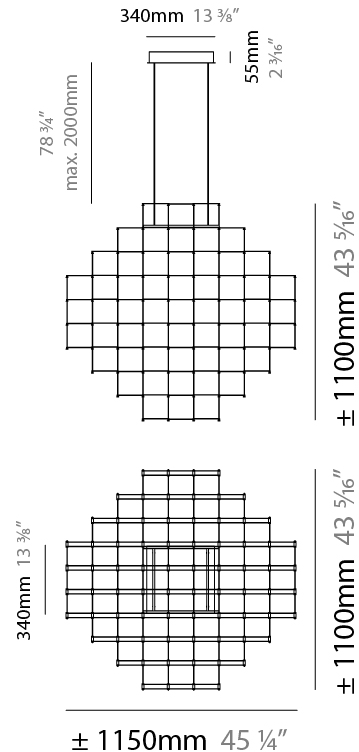
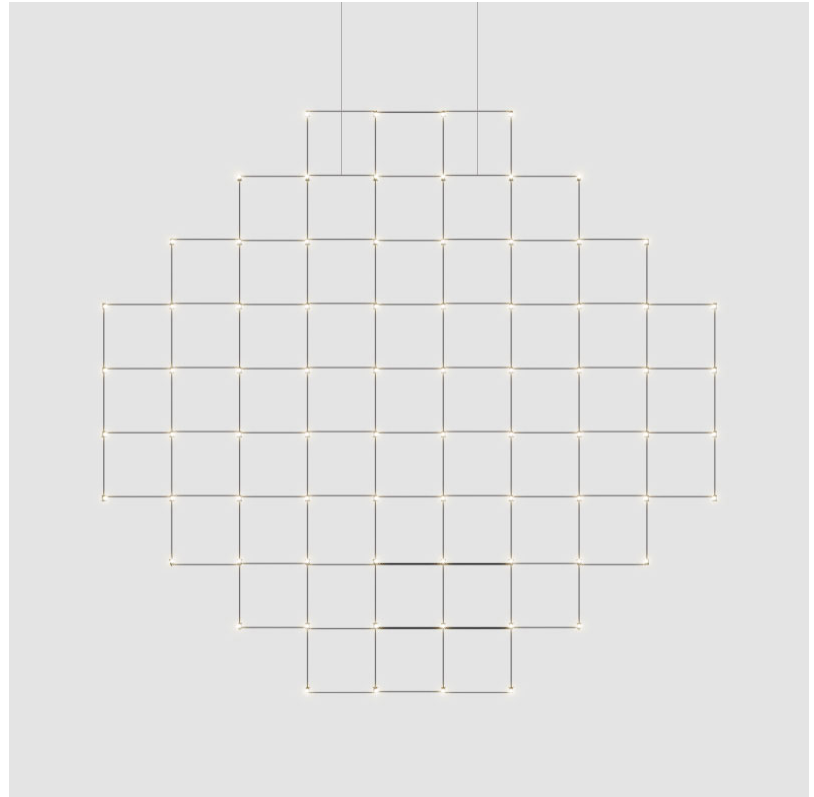

## PIXEL SPHERE SUSPENSION

D1010079-

PROJECT \_\_\_\_\_

TYPE \_\_\_\_\_

SPECIFIER \_\_\_\_\_

QUANTITY \_\_\_\_\_

DATE \_\_\_\_\_

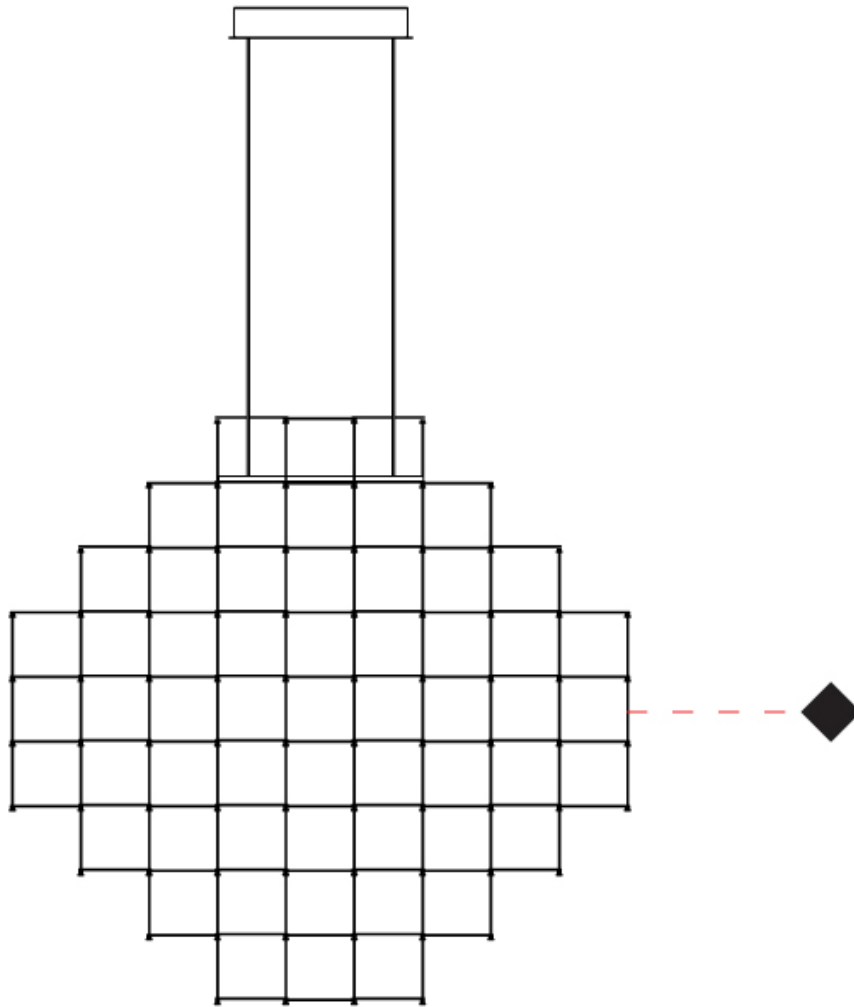

D

## PIXEL SPHERE SUSPENSION

**D1010080-** -

base number      Color      Finish  
 Temperature      Options

- To build a product code in our configurator select the specify button on the base model # product page
- To build a manual product code on this datasheet choose from the options listed below in blue font and add the suffix to the base model #

### GENERAL

Series: Pixel Sphere  
 Partner: Quasar  
 Division: Design  
 Installation: Suspension  
 Product Type: Chandelier  
 Mounting Location: Ceiling

### PHYSICAL

Shape: Sphere  
 Diameter (mm): 1400  
 Diameter (in): 55 <sup>1</sup>/<sub>8</sub>  
 Width (mm): 100  
 Width (in): 3 <sup>15</sup>/<sub>16</sub>  
 Height (mm): 100  
 Height (in): 3 <sup>15</sup>/<sub>16</sub>  
 Max. Overall Height (mm): 2100  
 Max. Overall Height (in): 82 <sup>11</sup>/<sub>16</sub>  
 Fixture Finish: [NIC](#) / [BRA](#) / [BBR](#)  
 Fixture Material: Metal  
 Cable Details: 2,000mm/78 3/4" Transparent Cable

### ELECTRICAL

Lamp Type: LED  
 Input Wattage (W): 876  
 Total Output Wattage (W): 745  
 Max. Wattage Per Lamp (W): 0.6  
 Dimming: 0-10V Dimming / Phase Dimming (120Vac Only)  
 Driver Included: Yes  
 Driver Location: Integrated  
 Driver Type: Constant Voltage - Universal  
 Driver Class: Class 1  
 Input Voltage (V): 120 - 277  
 Output Voltage (V): 12

### LED

Number of LEDs: 1460  
 Color Temperature (°K): [2400](#) / [2800](#)  
 Max. Delivered Lumen (lm): 43800  
 CRI: >90 CRI  
 Lamp Life (hrs): 50000

### OPTICAL

### RATINGS AND CERTIFICATIONS

Certified By: Certified for North American Standards  
 IP rating: IP20

PROJECT
TYPE
SPECIFIER
QUANTITY
DATE

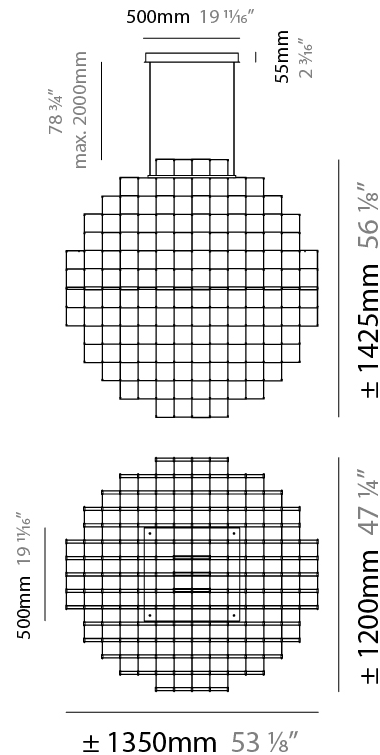
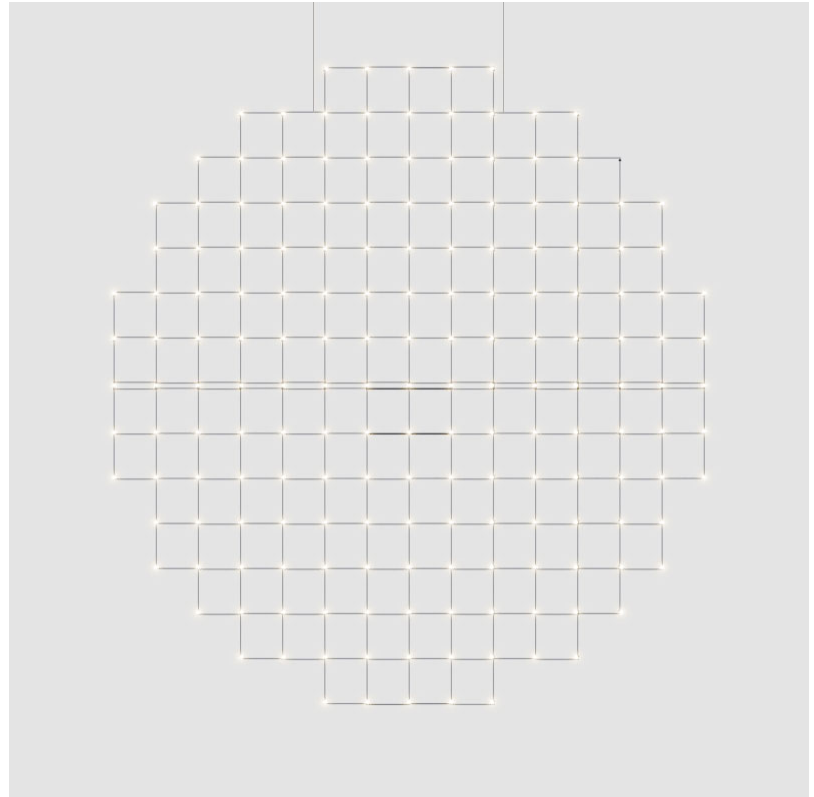

## PIXEL SPHERE SUSPENSION

D1010080-

PROJECT \_\_\_\_\_

TYPE \_\_\_\_\_

SPECIFIER \_\_\_\_\_

QUANTITY \_\_\_\_\_

DATE \_\_\_\_\_

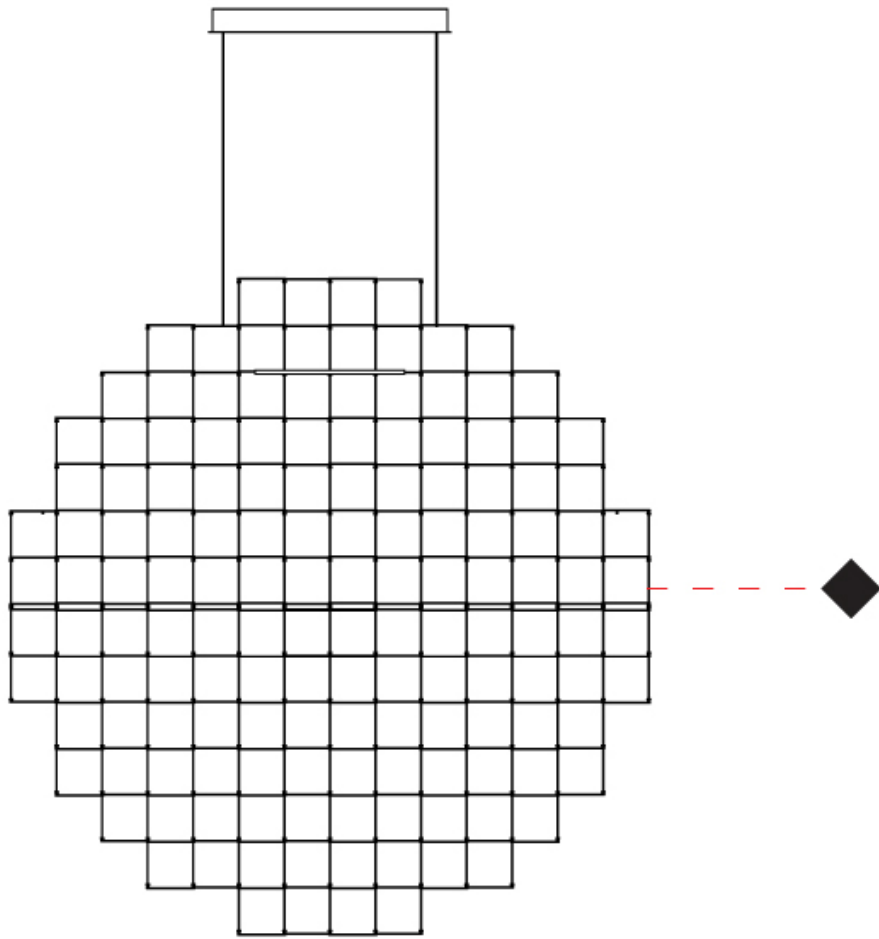

## PIXEL SPHERE SUSPENSION

### D1010081-

base number      Color      Finish  
 Temperature      Options

- To build a product code in our configurator select the specify button on the base model # product page
- To build a manual product code on this datasheet choose from the options listed below in blue font and add the suffix to the base model #

#### GENERAL

Series: Pixel Sphere  
 Partner: Quasar  
 Division: Design  
 Installation: Suspension  
 Product Type: Chandelier  
 Mounting Location: Ceiling

#### PHYSICAL

Shape: Sphere  
 Diameter (mm): 1400  
 Diameter (in): 55 <sup>1</sup>/<sub>8</sub>  
 Width (mm): 125  
 Width (in): 4 <sup>15</sup>/<sub>16</sub>  
 Height (mm): 125  
 Height (in): 4 <sup>15</sup>/<sub>16</sub>  
 Max. Overall Height (mm): 2125  
 Max. Overall Height (in): 83 <sup>11</sup>/<sub>16</sub>  
 Fixture Finish: [NIC](#) / [BRA](#) / [BBR](#)  
 Fixture Material: Metal  
 Cable Details: 2,000mm/78 3/4" Transparent Cable

#### ELECTRICAL

Lamp Type: LED  
 Input Wattage (W): 408  
 Total Output Wattage (W): 347  
 Max. Wattage Per Lamp (W): 0.6  
 Dimming: 0-10V Dimming / Phase Dimming (120Vac Only)  
 Driver Included: Yes  
 Driver Location: Integrated  
 Driver Type: Constant Voltage - Universal  
 Driver Class: Class 1  
 Input Voltage (V): 120 - 277  
 Output Voltage (V): 12

#### LED

Number of LEDs: 680  
 Color Temperature (°K): [2400](#) / [2800](#)  
 Max. Delivered Lumen (lm): 20400  
 CRI: >90 CRI  
 Lamp Life (hrs): 50000

#### OPTICAL

#### RATINGS AND CERTIFICATIONS

Certified By: Certified for North American Standards  
 IP rating: IP20

PROJECT
TYPE
SPECIFIER
QUANTITY
DATE

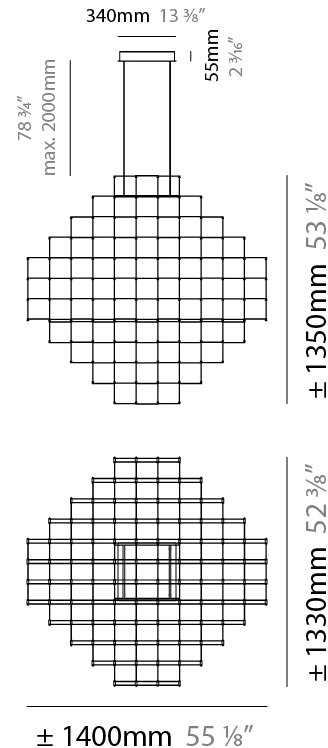
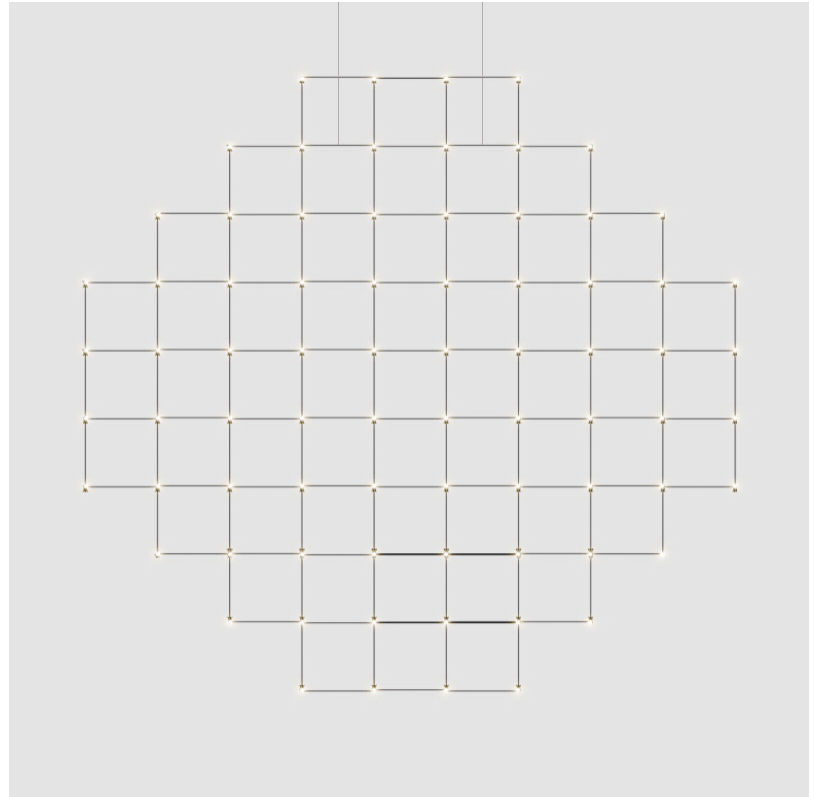

## PIXEL SPHERE SUSPENSION

D1010081-

PROJECT

TYPE

SPECIFIER

QUANTITY

DATE

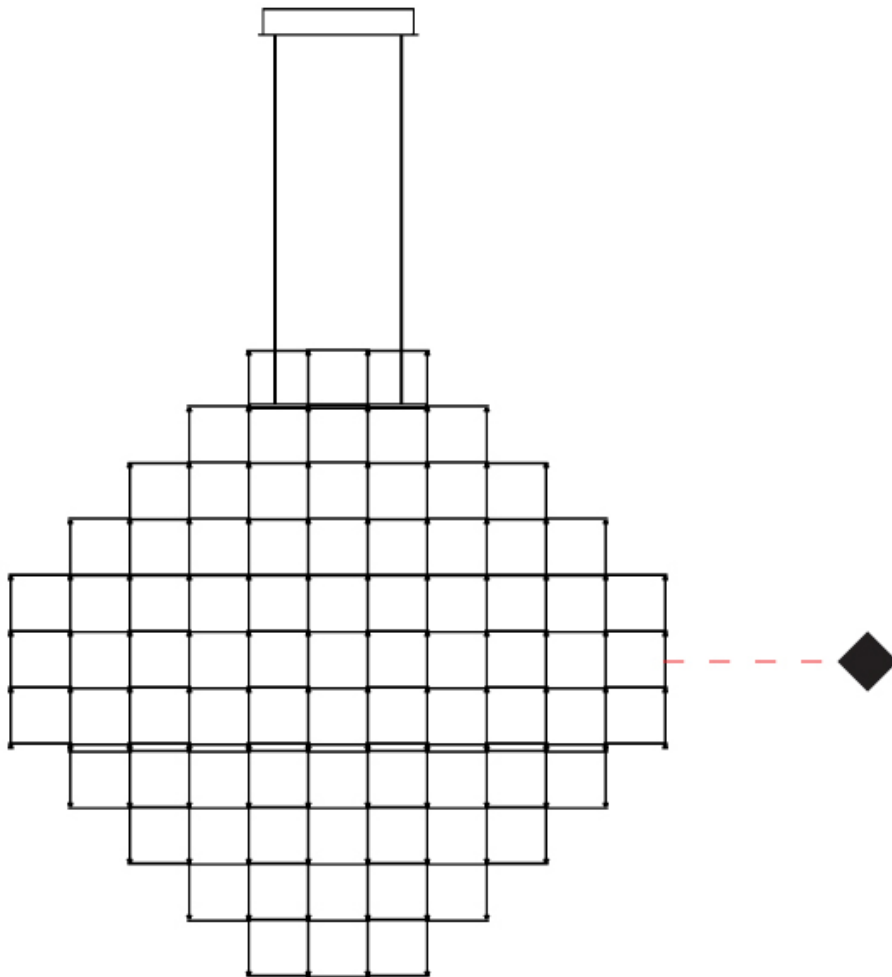

D

PROJECT	_____
TYPE	_____
SPECIFIER	_____
QUANTITY	_____
DATE	_____

## PIXEL SPHERE SUSPENSION

### D1010090- -

base number      Color      Finish  
 Temperature      Options

- To build a product code in our configurator select the specify button on the base model # product page
- To build a manual product code on this datasheet choose from the options listed below in blue font and add the suffix to the base model #

#### GENERAL

Series: Pixel Sphere  
 Partner: Quasar  
 Division: Design  
 Installation: Suspension  
 Product Type: Chandelier  
 Mounting Location: Ceiling

#### PHYSICAL

Shape: Sphere  
 Length (mm): 1350  
 Length (in): 53 1/8  
 Width (mm): 1200  
 Width (in): 47 1/4  
 Height (mm): 1430  
 Height (in): 56 5/16  
 Max. Overall Height (mm): 3430  
 Max. Overall Height (in): 135 1/16  
 Fixture Finish: [NIC](#) / [BRA](#) / [BBR](#)  
 Fixture Material: Metal  
 Cable Details: 2000mm/78 3/4" Transparent Cable

#### ELECTRICAL

Lamp Type: LED  
 Input Wattage (W): 876  
 Total Output Wattage (W): 745  
 Max. Wattage Per Lamp (W): 0.6  
 Dimming: 0-10V Dimming / Phase Dimming (120Vac Only)  
 Driver Included: Yes  
 Driver Location: Integrated  
 Driver Type: Constant Voltage - Universal  
 Driver Class: Class 1  
 Input Voltage (V): 120 - 277  
 Output Voltage (V): 12

#### LED

Number of LEDs: 1476  
 Color Temperature (°K): [2400](#) / [2800](#)  
 Max. Delivered Lumen (lm): 33580  
 CRI: >90 CRI  
 Lamp Life (hrs): 50000

#### OPTICAL

#### RATINGS AND CERTIFICATIONS

Certified By: Certified for North American Standards  
 IP rating: IP20

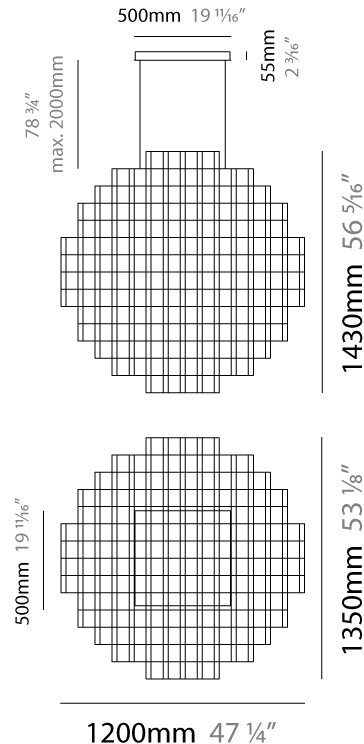
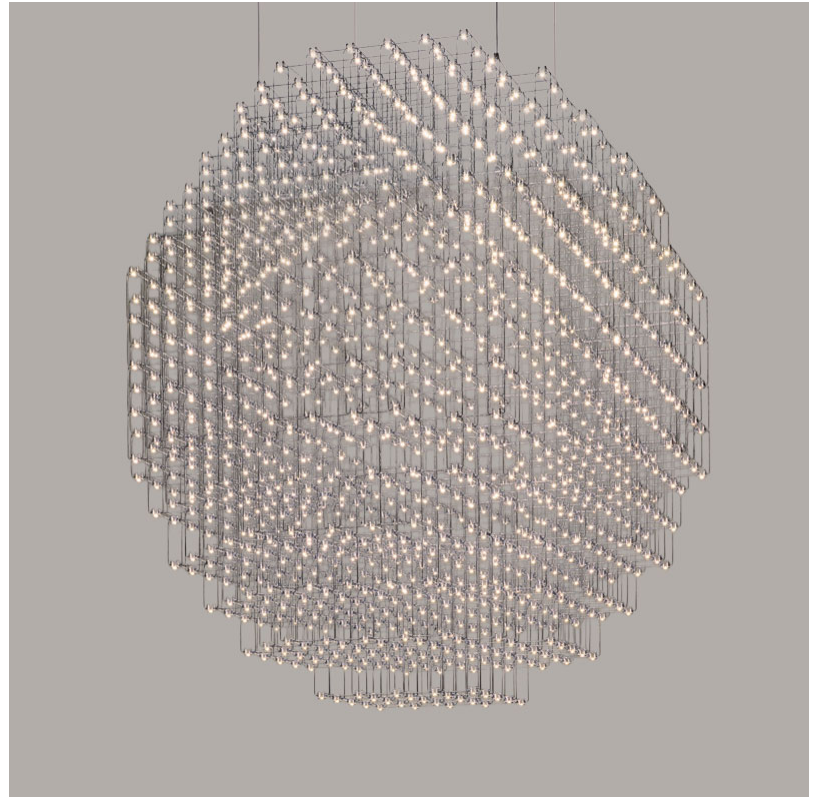

## PIXEL SPHERE SUSPENSION

D1010090-

PROJECT \_\_\_\_\_

TYPE \_\_\_\_\_

SPECIFIER \_\_\_\_\_

QUANTITY \_\_\_\_\_

DATE \_\_\_\_\_

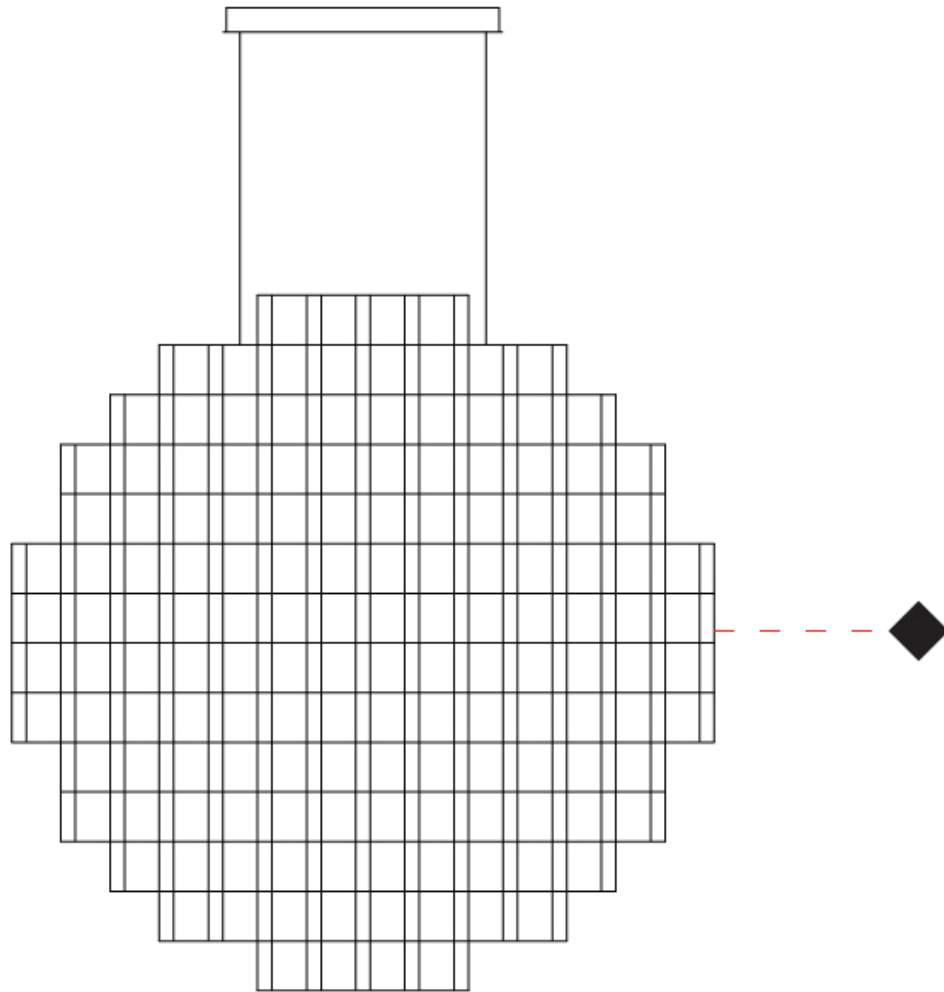

D

PROJECT	
TYPE	
SPECIFIER	
QUANTITY	
DATE	

## PIXEL SPHERE SUSPENSION

### D1010090- : D1010090-28K-BBR

base number Color Finish  
Temperature Options

- To build a product code in our configurator select the specify button on the base model # product page
- To build a manual product code on this datasheet choose from the options listed below in blue font and add the suffix to the base model #

#### GENERAL

Series: Pixel Sphere  
 Partner: Quasar  
 Division: Design  
 Installation: Suspension  
 Product Type: Chandelier  
 Mounting Location: Ceiling

#### PHYSICAL

Shape: Sphere  
 Length (mm): 1350  
 Length (in): 53 1/8  
 Width (mm): 1200  
 Width (in): 47 1/4  
 Height (mm): 1430  
 Height (in): 56 5/16  
 Max. Overall Height (mm): 3430  
 Max. Overall Height (in): 135 1/16  
 Fixture Finish: [NIC](#) / [BRA](#) / [BBR](#)  
 Fixture Material: Metal  
 Cable Details: 2000mm/78 3/4" Transparent Cable

#### ELECTRICAL

Lamp Type: LED  
 Input Wattage (W): 876  
 Total Output Wattage (W): 745  
 Max. Wattage Per Lamp (W): 0.6  
 Dimming: 0-10V Dimming / Phase Dimming (120Vac Only)  
 Driver Included: Yes  
 Driver Location: Integrated  
 Driver Type: Constant Voltage - Universal  
 Driver Class: Class 1  
 Input Voltage (V): 120 - 277  
 Output Voltage (V): 12

#### LED

Number of LEDs: 1476  
 Color Temperature (°K): [2400](#) / [2800](#)  
 Max. Delivered Lumen (lm): 33580  
 CRI: >90 CRI  
 Lamp Life (hrs): 50000

#### OPTICAL

#### RATINGS AND CERTIFICATIONS

Certified By: Certified for North American Standards  
 IP rating: IP20

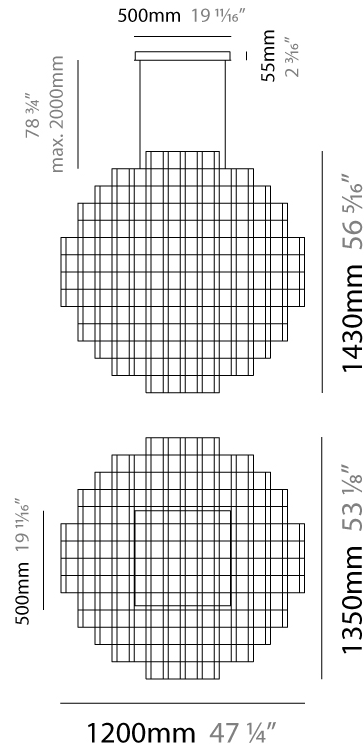
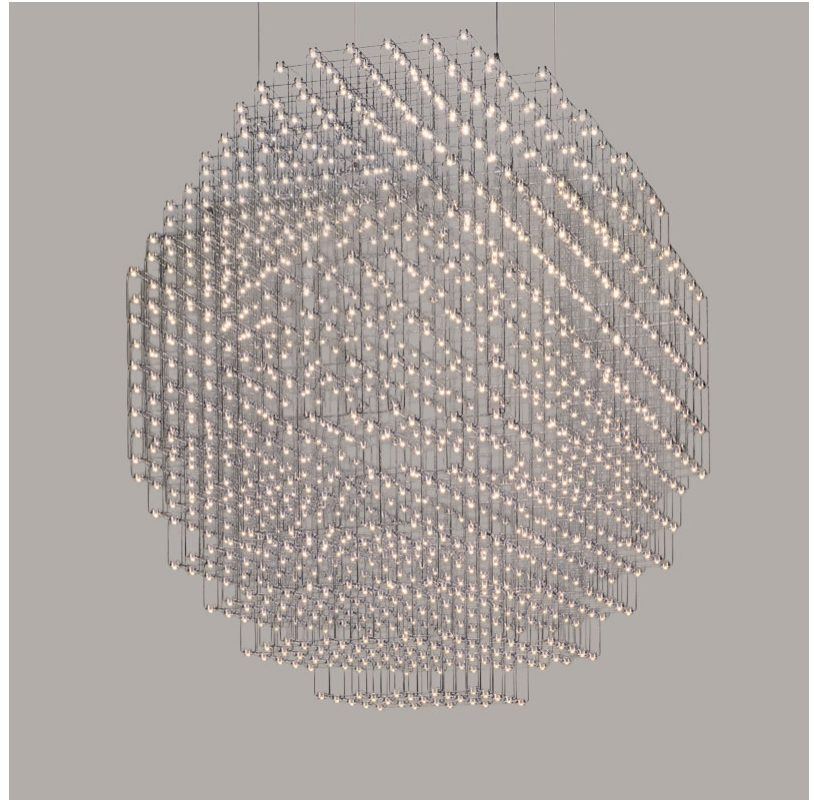

## PIXEL SPHERE SUSPENSION

D1010090- : D1010090-28K-BBR

PROJECT

TYPE

SPECIFIER

QUANTITY

DATE

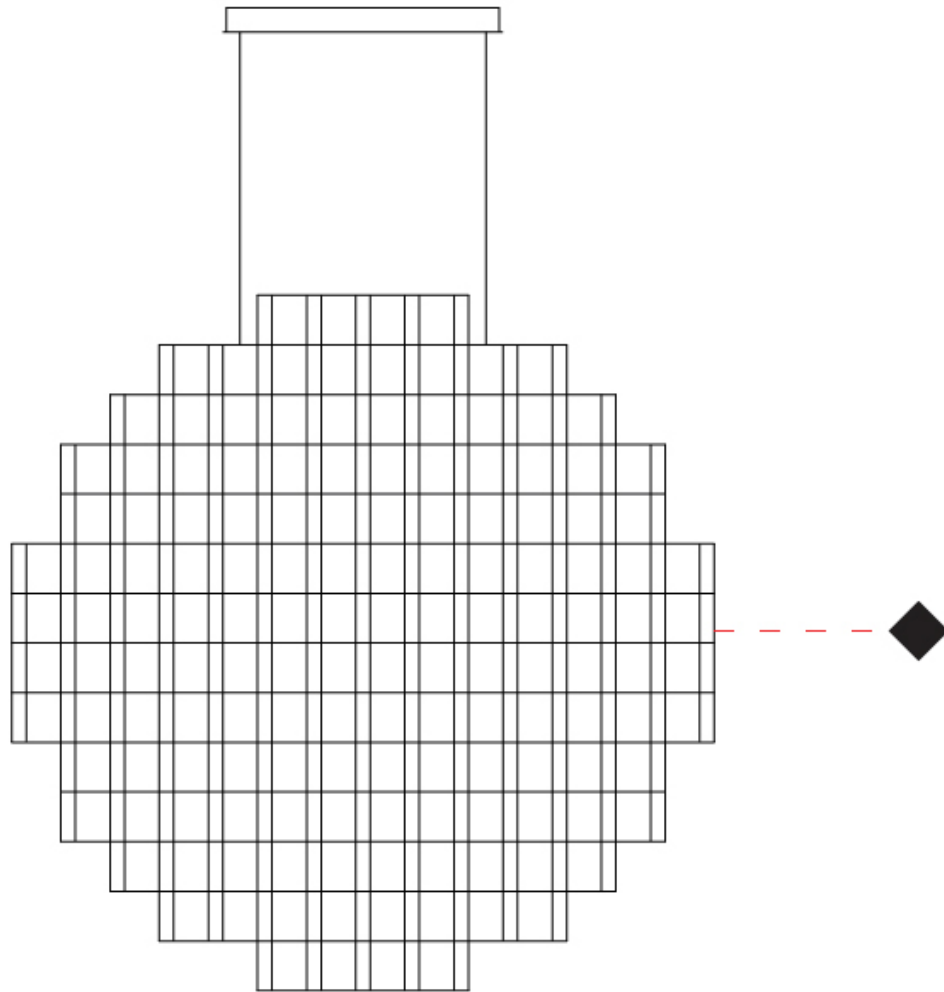

D

## PIXEL SPHERE COLOR FINISH CHART

PROJECT	_____
TYPE	_____
SPECIFIER	_____
QUANTITY	_____
DATE	_____

### Fixture Finish

Nickel - NIC



Brass - BRA



Black Brass - BBR

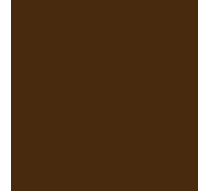

**Digital:** Not all screens are calibrated the same, and therefore, colors will appear differently between screens.

**Physical:** When texture is involved, there will be variations in color, character and tone within a product series and between product families.

Brass, nickel and copper are natural minerals and can potentially change color and show marks over time. We cannot guarantee the color appearance as the material transforms.



### LEGEND

	floor-mounted		pivotal		special LED (upon request) RGB, RGBW, tunable, gold+, meat+, art+, fashion+
	wall and ceiling: recessed and surface mounted		rotating		warm dim / natural dimming LED
	ceiling-mounted and wall-mounted		illuminate tilted		rechargeable battery powered
	wall-mounted		color of suspension cable		fixture with natural vivid LED (upon request)
	omni-directional light distribution		length of suspension cable		color rendering index
	direct light distribution		reflector degree selection		color temperature
	direct/indirect light distribution		super spot		lumen (luminous flux)
	indirect light distribution		lens		efficacy (lumens per watt)
	asymmetric light distribution		lens pack		Unified Glare Rating (UGR) range from 5-40
	aura light distribution		shine ring		marine grade (AISI 316 stainless steel)
	round wall or ceiling cut-out		integrated shine ring with diffuser		walk on
	square wall or ceiling cut-out		free individual colors 01-29		drive on
	the supplied jig specifies the cutout dimensions		individual colors: 00 (free of charge), 01-25 (extra charge)		Dark Sky Compliance
	minimum distance (meters) lamp - object		luminaire part to be colored (F1)		Americans with Disabilities Act (less than 4" off the wall located between 27"-84" from floor)
	recessed depth		luminaire part to be colored (F2)		lamp protected against explosion
	ceiling thickness in mm		luminaire part to be colored (F3)		blown glass using traditional methods by master glass blower
	ceiling thickness selection		luminaire part to be colored (F4)		acoustic material
	dimmable DP (phase), DV (0-10V), DD (dali), DS (step-dim)		luminaire part to be colored (F5)		protection class I, protection insulation
	included or excluded LED driver/transformer/control gear		color of 3-circuit adaptor		protection class II, protection insulation
	separately switchable		indirect diffuser		ETL Certified to UL and CSA Standards
	sensor		direct diffuser		UL Certified to UL and CSA Standards
	remote control		ball-proof (upon request)		CSA Certified to UL and CSA Standards
	available upon request		accessory		Certified for North American Standards

### IP RATING

	protected against ingress of solid bodies greater than 12.5mm (finger)
	protected against ingress of solid bodies greater than 2.5mm protected against sprays of water up to 60 degrees from the vertical (rain)
	protected against ingress of solid bodies greater than 1mm (wire) no protection against the ingress of moisture
	protected against ingress of solid bodies greater than 1mm (wire) protected against sprays of water up to 60 degrees from the vertical (rain)
	protected against ingress of solid bodies greater than 1mm (wire) protected against water splashed from all directions
	protected against limited ingress of dust (wet rooms/covered outdoor areas) protected against water splashed from all directions
	protected against ingress of dust protected against jets of water
	protected against ingress of dust protected against powerful jets of water or heavy seas
	protected against ingress of dust protected against immersion of water between 15cm - 1m for 30 minutes
	protected against ingress of dust protected against immersion of water under pressure for long periods

### IK RATING

	protected against 0.14 joules impact (equivalent to 0.25kg mass dropped from 56mm above the surface)
	protected against 0.2 joules impact (equivalent to 0.25kg mass dropped from 80mm above the surface)
	protected against 0.35 joules impact (equivalent to 0.25kg mass dropped from 140mm above the surface)
	protected against 0.5 joules impact (equivalent to 0.25kg mass dropped from 200mm above the surface)
	protected against 0.7 joules impact (equivalent to 0.25kg mass dropped from 280mm above the surface)
	protected against 1 joules impact (equivalent to 0.25kg mass dropped from 400mm above the surface)
	protected against 2 joules impact (equivalent to 0.5kg mass dropped from 400mm above the surface)
	protected against 5 joules impact (equivalent to 1.7kg mass dropped from 300mm above the surface)
	protected against 10 joules impact (equivalent to 5.0kg mass dropped from 200mm above the surface)
	protected against 20 joules impact (equivalent to 5.0kg mass dropped from 400mm above the surface)